

Data sheet

Motorized Torque Control System

UD5M0050-060-NGNG2

Main functions	
Nominal moment	5 Nm
Max. axial force	400 N
Max. radial force	200 N
Nominal revolution	600 U/min
Acceleration	20000 °/s ²
Dwell time of nominal moment	No limitation
Weight mechanics	8,4 kg
Max. tool mass moment of inertia at α Nom	0,0071 kg*m ²
Max. tool mass moment of inertia	0,0071 kg*m ²
Torque	
Measuring principle	DMS
System accuracy*	< 1 % with 2-point-calibration / < 0,5 % with characteristic map
Amplifier PDM-S / (WxHxD)	Aluminum die-cast / 125 x 80 x 57 mm
Output signal	digital
Protection class	IP40
Power supply	19...36 VDC (3 W)
Distance measuring	
Feedback device	Multiturn
Repeatability of positioning**	< 5 arcmin
Servo amplifier	
Type	M702-034-00025-A
Dimensions (WxHxD)	83 x 382 x 200 mm
Mains voltage	3 AC 380 V ... 480 V, +/-10 %
Cable cross section (input)	IEC 1,5 mm ² / UL 18 AWG

Servo amplifier	
Cable cross section (output)	IEC 1,5 mm ² / UL 18 AWG
Protection class	IP20
Weight	4 kg
Recommended protection	IEC 10 A gG UL/USA 10 A CC or J
Temperature range	-20 °C...+50 °C
Power loss	94 W
Line filter	
Weight	2 kg
Cable cross section (input)	4 mm ² / 12 AWG
Power loss	13 W
Dimensions (WxHxD)	83 x 426 x 41 mm
Protection class	IP20
Interfaces	
PC	Ethernet
PLC (24 VDC)	3I / 4O
PLC Fieldbus	Profibus, Profinet, EtherCat, EtherNet/IP, Modbus/TCP
Extension Options PROMESS Bus	PDM-A: 4x analogue / PDM-P: Piezo / PDM-I/O: 16I / 16O

* Force measuring system, static calibration

** at thermal steady-state

All nominal values refer to 400 V mains voltage.

Order code: **UD5M0050-060-NGNG2**

Drive feedback device

M: Multiturn / I: Singleturn

Nominal torque in Nm/10

Nominal rot. speed in U/min*10

Add. feedback device

N: none / M: Multiturn

Output shaft

G: flat / P: fitted key

Drive voltage

Z: single phase 230 V / G: tri. phase 400 V

Revision number

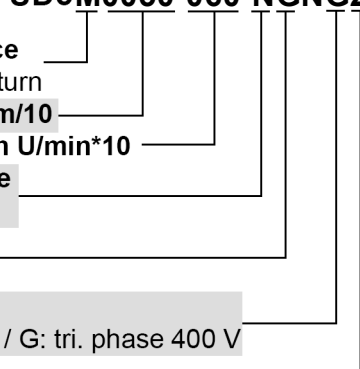

For more efficiency.

